



THANK YOU FOR VOTING TEXECOM

INSTALLATION MANUAL

Premier OP16

Output Expander



Texecom
www.texecom.com

Contents

1. Overview.....	3
General.....	3
Output Expander Layout.....	4
2. Installation.....	6
Mounting	6
Connecting Output Expanders	7
Wiring the Network.....	7
Network Connections.....	8
Cable Distances	8
Overcoming Voltage Drop.....	9
Installing a Power Supply.....	9
Addressing the Expander.....	10
Expander Output Numbering	11
Wiring Devices to the Outputs	12
Testing the Expander.....	13
3. Specifications	14
Electrical	14
Environmental.....	14
Physical.....	15
Standards.....	15
Warranty.....	15

1. Overview

General

The *Premier OP16* Output Expander is only compatible with the following control panels:

- *Premier 888*
- *Premier 8168*

Output expanders, keypads and zone expanders are all connected to the same network terminals located at the bottom left hand corner of the control panel and may be connected serially (daisy chain), in parallel (star) or any combination of the two.



A maximum of 8 zone expanders, 8 keypads and 4 output modules can be connected to each network.

Output Expander Features

- 16 fully programmable outputs (100mA '-ve' applied each)
- Tamper output

Output Expander Layout

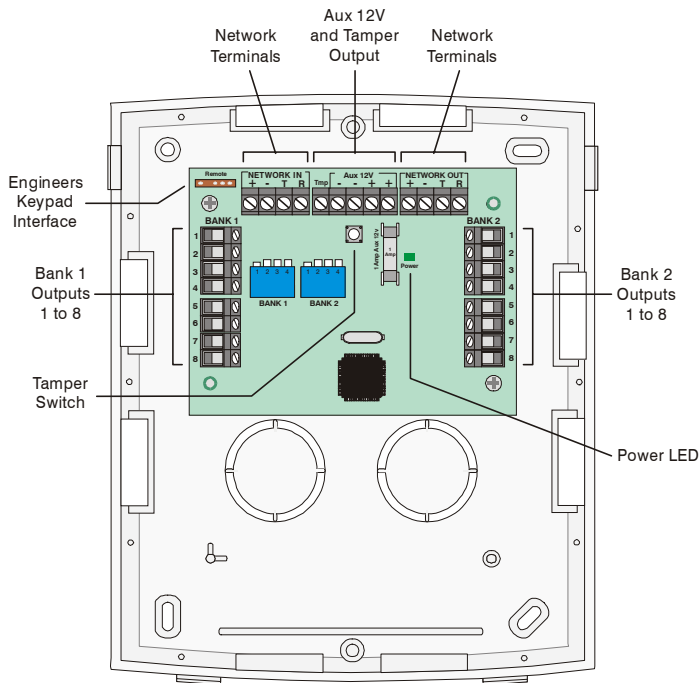

Tamper Switch

This is the cover tamper switch and provides tamper protection for the expander.

Tamper Output

This is the cover tamper output and would normally be connected to an input on the control panel or zone expander to indicate a tamper fault.

Engineers Keypad Interface

A portable Engineers keypad can be plugged on to this connector to allow easier access for programming and testing.



When using a keypad as an Engineer's keypad, the address DIL switches must all be in the 'On' position.

Network Terminals

These terminals must be connected to the corresponding terminals on the control panel or previous device (see page 8 for wiring details). The '+' and '-' terminals provide power for the keypad whilst the 'T' transmits data and 'R' receives data.

Power LED

This Power LED indicates that the expander has got power connected to it.

Aux 12V

These terminals are for connecting devices that require 12V power (protected by a 1A fuse).

Bank 1 Address Switch

This switch sets the address of the zone expander that Bank 1 outputs 1 to 8 will mimic (see page 10 for details).



Never set two expanders on the same network to the same address.

Bank 2 Address Switch

This switch sets the address of the zone expander that Bank 2 outputs 1 to 8 will mimic (see page 10 for details).



Never set two expanders on the same network to the same address.

Bank 1 Outputs 1 to 8

These outputs are low current (100mA '-ve' applied) and can be used to drive auxiliary devices such as LED's, sounders or relays etc.

Bank 2 Outputs 1 to 8

These outputs are low current (100mA '-ve' applied) and can be used to drive auxiliary devices such as LED's, sounders or relays etc.

2. Installation

Mounting

Remove each screw cap by inserting a flat bladed screwdriver into the slot and turning anti-clockwise, excessive force is **NOT** required. Remove both of the cover screws and put them in a safe place along with the screw caps. Gently pull the cover away from the base applying slight pressure to the sides at the top of the expander if required. The front cover should now be off.

Mount the expander using at least two appropriate countersunk screws (no larger than No. 8). Slotted holes have been provided to assist mounting and aid levelling.

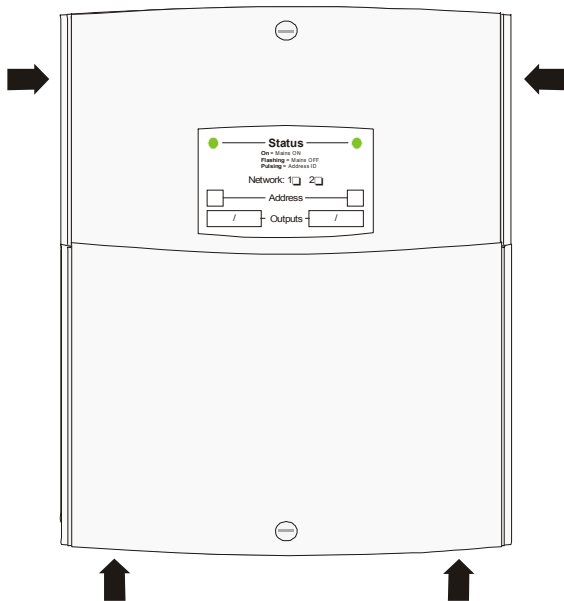

Connecting Output Expanders

Before connecting output expanders, isolate **ALL** power from the control panel (AC Mains and Battery). Do not continue if there is power still present on the control panel.



NOTE Connecting an expander with power still present on the control panel may damage the expander or control panel and invalidate any warranty.

Output expanders, keypads and zone expanders are all connected to the same network terminals located at the bottom left hand corner of the control panel and may be connected serially (daisy chain), in parallel (star) or any combination of the two.



NOTE A maximum of 4 output expanders, 8 keypads and 8 zone expanders can be connected to each network.

Whenever new devices are connected to the network, they must be confirmed onto the system using the 'Confirm Devices' menu option. For details on confirming devices please refer to the *Premier 888/8168* Installation Manual.

Wiring the Network

The networks are made up of four terminals incorporating power and data. To ensure correct operation, all four terminals on the device must be connected to the corresponding terminals on the control panel or previous device. The table below shows each terminal and its description:

Terminal	Description
+	+12V Supply
-	0V Supply
T	Transmit Data
R	Receive Data

Output expanders can be connected using 4-core cable. However, it is recommended that 6 or 8-core cable is used as the spare cores can be used to 'Double Up' on the power connections if needed.



NOTE Standard 7/0.2 alarm cable can be used for most installations. However, under certain conditions it may be necessary to use screened cable.

Network Connections

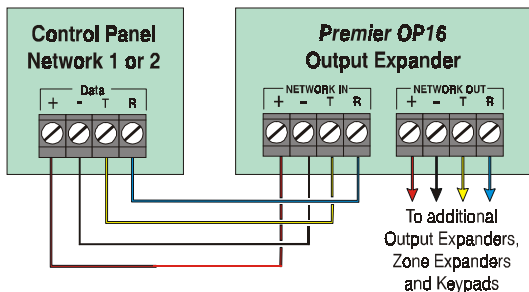

Cable Distances

The maximum recommended distance for output expanders when using standard 7/0.2 alarm cable is:

- 250m for each branch when using the star (parallel) configuration
- When using a daisy chain (series) configuration the maximum distance will depend on the number of devices connected on the chain. The more devices that are connected, the shorter the distance to the last device (this is due to voltage drop in the cable)

Whichever method of wiring configuration is used, ensure that the voltage between the '+' and '-' terminals at each device is no lower than 10.0V when the system is running on the standby battery. The table below shows maximum cable runs when one keypad is installed using standard 7/0.2 alarm cable:

Configuration	Max. Cable Run
1. Expander + 8 LED's @15mA	100m
2. Expander + 16 LED's @15mA	80m

Distances of up to 1km can be achieved between the control panel and an output expander. However, a power supply must be installed close to the expander to power it locally, this will help to overcome voltage drop caused by the long cable run.

Overcoming Voltage Drop

There are several ways to overcome voltage drop:

- Use thicker lower resistance cable. Standard 7/0.2 alarm cable has a resistance of 8Ω per 100m
- Double up on the power connections - this will require using a 6 or 8-core cable rather than a 4-core cable
- Install a power supply to power the device locally, remember to common the two negative connections

Installing a Power Supply

When a power supply is installed, the 0V connection on the power supply must be connected through to 0V on the control panel and the +12V connection between the control panel and the expander must not be connected.

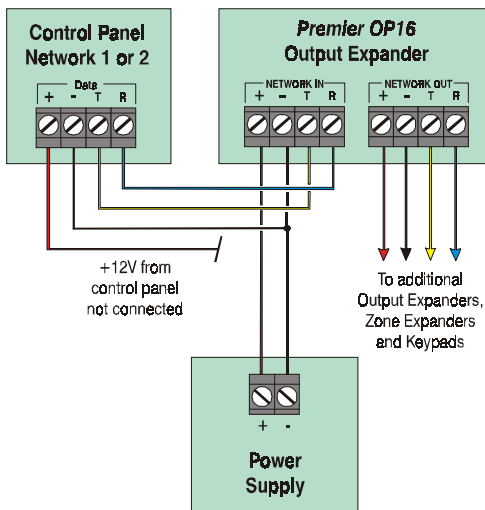

Addressing the Expander

Each output expander can be addressed to mimic the outputs of up to two zone expanders.



NOTE

In order for an output expander to mimic zone expander outputs, the output expander must be addressed the same as the zone expander it is mimicking.

Any combination of addresses can be used on each output expander i.e. Bank 1 can be addressed to mimic zone expander 3 and Bank 2 can be addressed to mimic zone expander 8

Each bank on the output module must be assigned a different address using the DIL switches located on the left hand side of the PCB.



NOTE

Bank 1 switch sets the address of the zone expander that Bank 1 outputs 1 to 8 will mimic.

Bank 2 switch sets the address of the zone expander that Bank 2 outputs 1 to 8 will mimic.

The table below shows the expander addressing:

Address	DIL 1	DIL 2	DIL 3	DIL 4
1	On or Off	Off	Off	Off
2	Off	On	Off	Off
3	Off	Off	On	Off
4	Off	Off	Off	On
5	On	Off	Off	On
6	Off	On	Off	On
7	Off	Off	On	On
8	On	Off	On	On



NOTE

Never set two output expanders on the same network to the same address.

Banks 1 and 2 on the output expanders are both factory set to address 1.

Expander Output Numbering

The table below shows the output allocation when output expanders are installed:

Address	Expander Outputs (Network 1)	Expander Outputs (Network 2)
1	1 - 8	1 - 8
2	1 - 8	1 - 8
3	1 - 8	1 - 8
4	1 - 8	1 - 8
5	1 - 8	1 - 8
6	1 - 8	1 - 8
7	1 - 8	1 - 8
8	1 - 8	1 - 8

Wiring Devices to the Outputs

The output expander has 16 fully programmable outputs. These outputs can be used to drive auxiliary devices such as LED's, sounders or relays etc. The table below shows the electrical characteristics for each output:

Bank	Outputs	Max Current	Type
1	1 to 8	100mA	Switched -ve
2	1 to 8	100mA	Switched -ve

The diagram below shows typical wiring examples for the outputs:

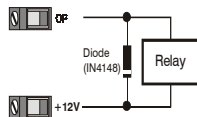
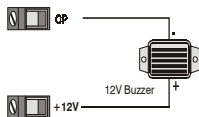
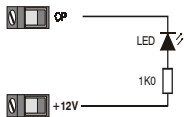

For details on programming outputs, please refer to the *Premier 888/8168* Installation Manual. Once the outputs have been programmed, they should also be tested to ensure correct operation (see page 13 for details).

Testing the Expander

Whenever new devices are connected to the networks, they must be confirmed onto the system using the 'Confirm Devices' menu option. For details on confirming devices, please refer to the *Premier 888/8168* Installation Manual.

Testing the Outputs

The outputs on the expander can be individually tested to ensure correct operation, this can be by done using the 'View Exp. Status' menu option. For details on testing outputs, please refer to the *Premier 888/8168* Installation Manual.

3. Specifications

Electrical

Operating Voltage	10 - 13.7V _{DC}
Current Consumption	
Quiescent	35mA
Network	4-wire standard 7/0.2 alarm cable up to 250m. Star, Daisy Chain or any combination of the two
Bank 1 Outputs	
O/P 1	100mA switched to 0V
O/P 2	100mA switched to 0V
O/P 3	100mA switched to 0V
O/P 4	100mA switched to 0V
O/P 5	100mA switched to 0V
O/P 6	100mA switched to 0V
O/P 7	100mA switched to 0V
O/P 8	100mA switched to 0V
Bank 2 Outputs	
O/P 1	100mA switched to 0V
O/P 2	100mA switched to 0V
O/P 3	100mA switched to 0V
O/P 4	100mA switched to 0V
O/P 5	100mA switched to 0V
O/P 6	100mA switched to 0V
O/P 7	100mA switched to 0V
O/P 8	100mA switched to 0V

Environmental

Operating Temperature	-10°C (+14°F) to +50°C (+122°F)
Storage Temperature	-20°C (-4°F) to +60°C (+140°F)
Maximum Humidity	95% non-condensing
EMC Environment	Residential Commercial Light / Heavy Industrial

Physical

Dimensions	145mm x 115mm x 30mm
Packed Weight	200g approx.

Standards

Conforms to European Union (EU) Electro-Magnetic Compatibility (EMC) Directive 89/336/EEC (amended by 92/31/EEC and 93/68/EEC).

The CE mark indicates that this product complies with the European requirements for safety, health, environmental and customer protection.

Warranty

All Texecom products are designed for reliable, trouble-free operation. Quality is carefully monitored by extensive computerised testing. As a result the *Premier OP16* Output Expander is covered by a two-year warranty against defects in material or workmanship.

As the *Premier OP16* Output Expander is not a complete alarm system but only a part thereof, Texecom cannot accept responsibility or liability for any damages whatsoever based on a claim that the *Premier OP16* Output Expander failed to function correctly.

Due to our policy of continuous improvement Texecom reserve the right to change specification without prior notice.

Premier is a trademark of Texecom Ltd.

Texecom

www.texe.com

Texecom Limited, Bradwood Court, St. Crispin Way, Haslingden, Lancashire
BB4 4PW, England.

Technical Support:

Tel: +44 (0)1706 234833

Tel: +44 (0)1706 234811

Fax: +44 (0)1706 213187

INS186